

RC5532/RC5532A

High Performance Dual Low Noise Operational Amplifier

Features

- Small signal bandwidth – 10 MHz
- Output drive capability – 600Ω, 10 VRMS
- Input noise voltage – 5 nV/√Hz
- DC voltage gain – 50,000
- AC voltage gain – 2200 at 10 kHz
- Power bandwidth – 140 kHz
- Slew rate – 8 V/μS
- Large supply voltage range – ±3V to ±20V

Description

The RC5532 is a high performance, dual low noise operational amplifier. Compared to standard dual operational amplifiers, such as the RC747, it shows better noise performance, improved output drive capability, and considerably higher small-signal and power bandwidths.

This makes the device especially suitable for application in high quality and professional audio equipment, instrumentation, control circuits, and telephone channel amplifiers. The op amp is internally compensated for gains equal to one. If very low noise is of prime importance, it is recommended that the RC5532A version be used which has guaranteed noise specifications.

Block Diagram

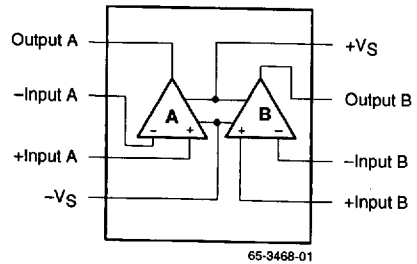

Pin Assignments

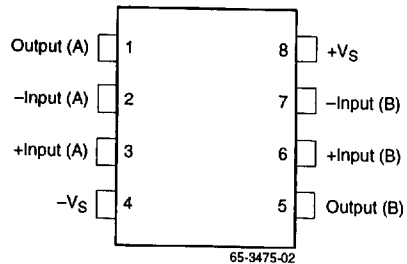
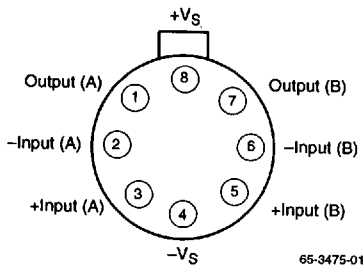

Absolute Maximum Ratings(beyond which the device may be damaged)¹

Parameter		Min	Typ	Max	Units
Supply Voltage				±22	V
Input Voltage				±Vs	V
Differential Input Voltage				0.5	V
P _{DTA} < 50°C	PDIP			468	mW
	CerDIP			833	
	SOIC			658	
Junction Temperature	PDIP			125	°C
	CerDIP, TO-99			175	
Storage Temperature		-65		150	°C
Operating Temperature	RM5532/A	-55		125	°C
	RC5532/A	0		70	
Lead Soldering Temperature (10 sec)				300	°C

Notes:

1. Functional operation under any of these conditions is NOT implied.
2. For supply voltages less than ±15V, the absolute maximum input voltage is equal to the supply voltage.
3. Short circuit to ground on one amplifier only.

Operating Conditions

Parameter		Min	Typ	Max	Units
θ _{JC}	Thermal resistance		CerDIP	45	°C/W
			TO-99	50	
θ _{JA}	Thermal resistance		PDIP	160	°C/W
			CerDIP	150	
			TO-99	190	
For T _A > 50°C Derate at			PDIP	6.25	mW/°C
			CerDIP	8.33	
			TO-99	5.26	

DC Electrical Characteristics

($V_S = \pm 15V$ and $T_A = +25^\circ C$ unless otherwise noted)

Parameters	Test Conditions	RM5532/5532A			RC5532/5532A			Units
		Min	Typ	Max	Min	Typ	Max	
Input Offset Voltage			0.5	2.0		0.5	4.0	mV
	Over Temperature			3.0			5.0	mV
Input Offset Current				100		10	150	nA
	Over Temperature			200			200	nA
Input Bias Current			200	400		200	800	nA
	Over Temperature			700			1000	nA
Supply Current			6.0	11		6.0	16	mA
	Over Temperature			13			22	mA
Input Voltage Range		± 12	± 13		± 12	± 13		V
Common Mode Rejection Ratio		80	100		70	100		dB
Power Supply Rejection Ratio		86	100		80	100		dB
Large Signal Voltage Gain	$R_L \geq 2\text{ k}\Omega$, $V_{OUT} = \pm 10V$	50			25	100		V/mV
	Over Temperature	25			15	50		
	$R_L \geq 600\Omega$, $V_{OUT} = \pm 10V$	40			15	50		
	Over Temperature	20			10			
Output Voltage Swing	$R_L \geq 600\Omega$	± 12	± 13		± 12	± 13		V
	$R_L = 600\Omega$, $V_S = \pm 18V$	± 15	± 16		± 15	± 16		
	$R_L \geq 2\text{ k}\Omega$	± 12	± 13					
Input Resistance (Diff. Mode)			300			300		k Ω
Short Circuit Current			38			38		mA

Notes:

- Diodes protect the inputs against over-voltage. Therefore, unless current-limiting resistors are used, large currents will flow if the differential input voltage exceeds 0.6V. Maximum input current should be limited to $\pm 10\text{mA}$.
- Over Temperature: RM = $55^\circ C \leq T_A \leq 125^\circ C$; RC = $0^\circ C \leq T_A \leq 70^\circ C$

Electrical Characteristics

($V_S = \pm 15V$ and $T_A = +25^\circ C$)

Parameters	Test Conditions	RC/RM5532			RC/RM5532A			Units
		Min	Typ	Max	Min	Typ	Max	
Input Noise Voltage Density	$F_O = 30\text{ Hz}$		8.0			8.0	12	nV/ $\sqrt{\text{Hz}}$
	$F_O = 1\text{ kHz}$		5.0			5.0	6.0	
Input Noise Current Density	$F_O = 30\text{ Hz}$		2.7			2.7		pA/ $\sqrt{\text{Hz}}$
	$F_O = 1\text{ kHz}$		0.7			0.7		
Channel Separation	$F = 1\text{ kHz}$, $R_S = 5\text{ k}\Omega$		110			110		dB

AC Electrical Characteristics

($V_S = \pm 15V$ and $T_A = +25^\circ C$)

Parameters	Test Conditions	Min	Typ	Max	Units
Output Resistance	$A_V = 30$ dB Closed Loop, $F = 10$ kHz, $R_L = 600\Omega$		0.3		Ω
Overshoot	Unity Gain, $V_{IN} = 100$ mV _{p-p} $C_L = 100$ pF, $R_L = 600\Omega$		10		%
Gain	$F = 10$ kHz		2.2		V/mV
Gain Bandwidth Product	$C_L = 100$ pF, $R_L = 600\Omega$		10		MHz
Slew Rate			8.0		V/ μ S
Power Bandwidth	$V_{OUT} = \pm 10V$		140		kHz
	$V_{OUT} = \pm 14V$, $R_L = 600\Omega$, $V_S = \pm 18V$		100		kHz

Test Circuits

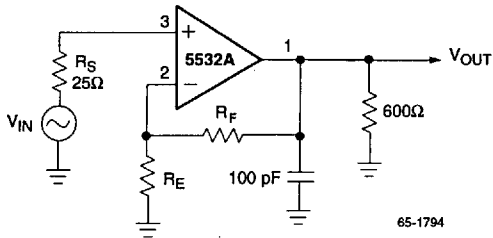

Figure 1. Closed Loop Frequency Response

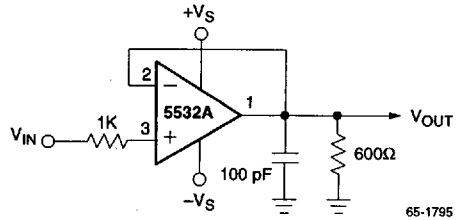

Figure 2. Follower, Transient Response

Typical Performance Characteristics

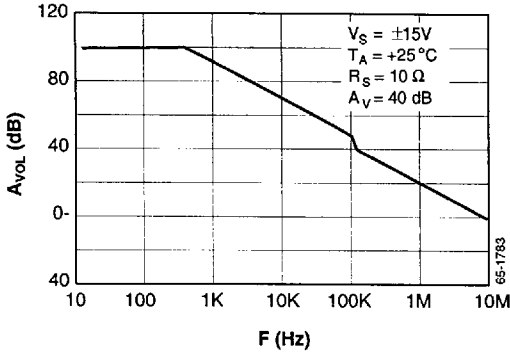

Figure 3. Open Loop Gain vs. Frequency

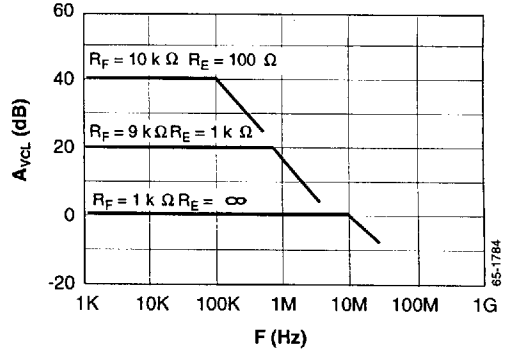

Figure 4. Closed Loop Gain vs. Frequency

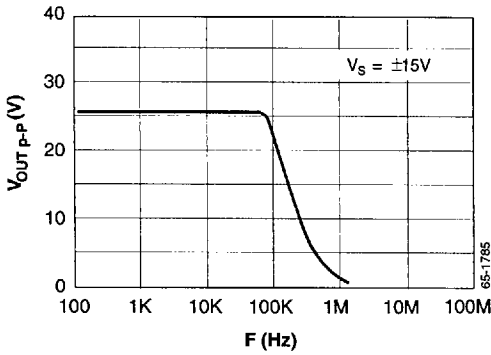

Figure 5. Output Voltage Swing vs. Frequency

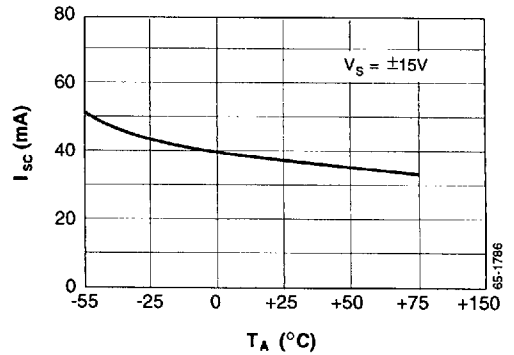

Figure 6. Short Circuit Current vs. Temperature

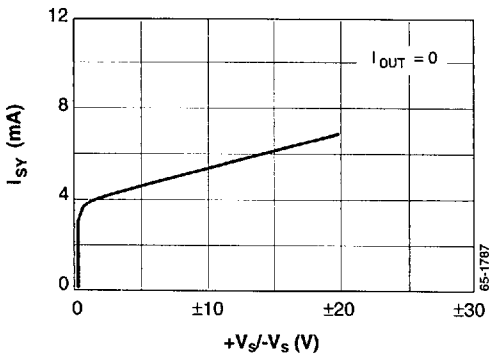

Figure 7. Supply Current vs. Supply Voltage

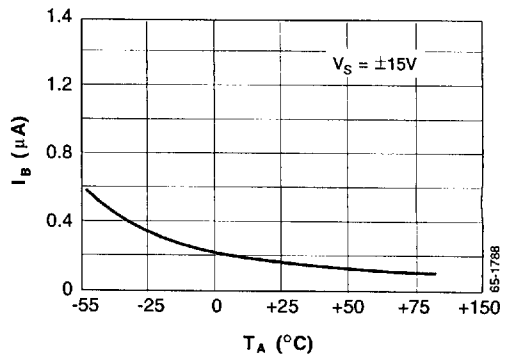

Figure 8. Input Bias Current vs. Temperature

Typical Performance Characteristics (continued)

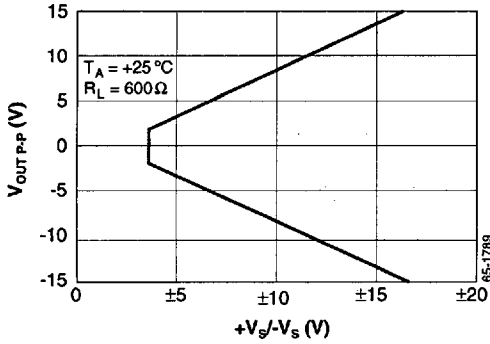

Figure 9. Output Voltage Swing vs. Supply Voltage

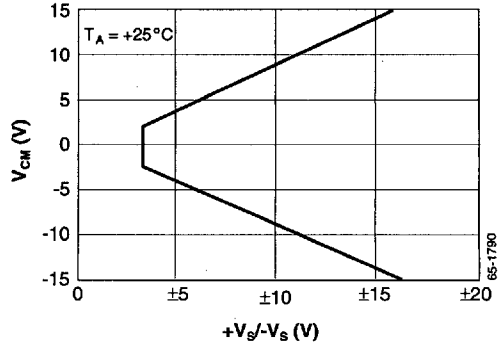

Figure 10. Common Mode Input Range vs. Supply Voltage

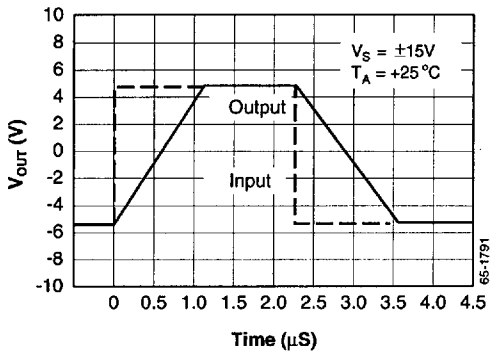

Figure 11. Follower Large Signal Pulse Response

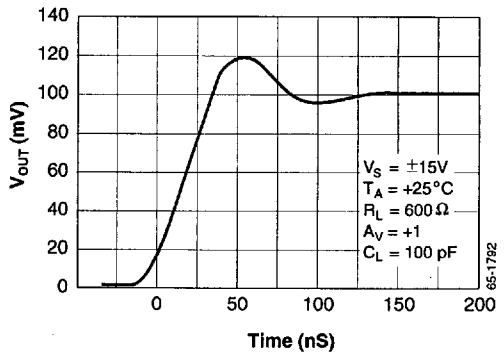

Figure 12. Transient Response Output Voltage vs. Time

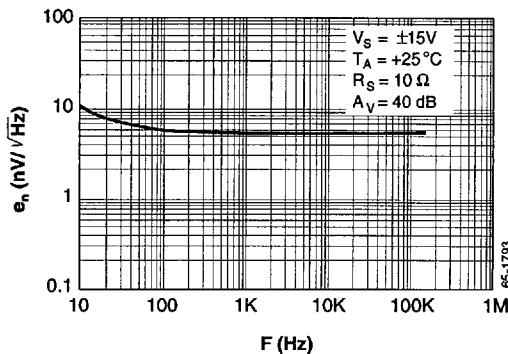
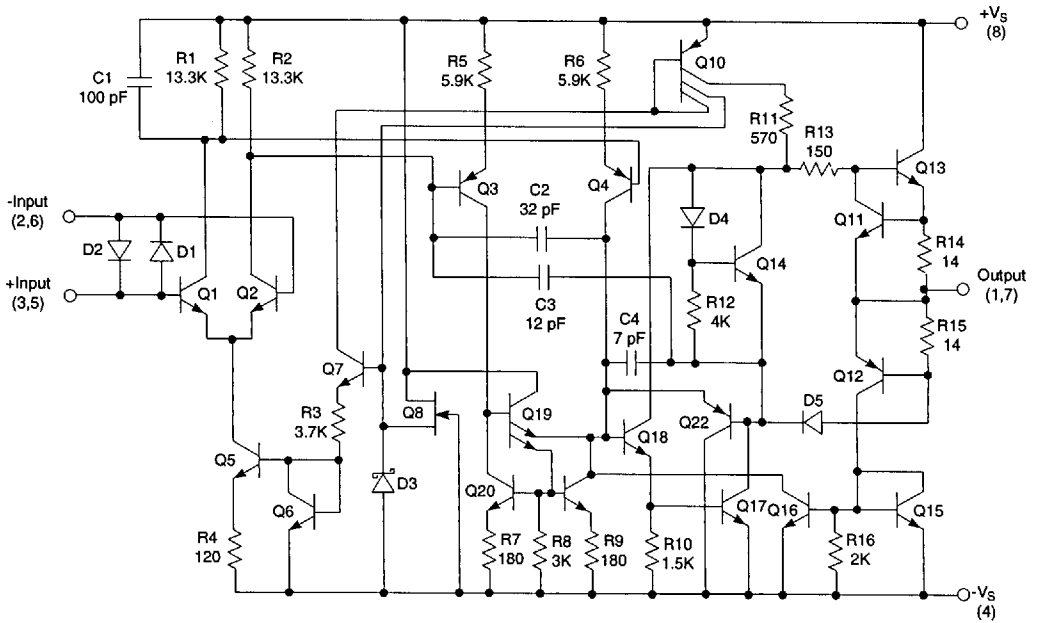

Figure 13. Input Noise Density vs. Frequency

Simplified Schematic Diagram (1/2 shown for 5532)



65-1780

ANALOG

Ordering Information

Product Number	Temperature Range	Screening	Package
RC5532D/RC5532AD	0°C to +70°C	Commercial	8 Pin Ceramic DIP
RC5532N/RC5532AN	0°C to +70°C	Commercial	8 Pin Plastic DIP
RM5532D/RM5532AD	-55°C to +125°C	Commercial	8 Pin Ceramic DIP
RM5532D/883B	-55°C to +125°C	Military	8 Pin Ceramic DIP
RM5532AD/883B	-55°C to +125°C	Military	8 Pin Ceramic DIP
RM5532T/RM5532AT	-55°C to +125°C	Commercial	8 Pin TO-99 Metal Can
RM5532T/883B	-55°C to +125°C	Military	8 Pin TO-99 Metal Can
RM5532AT/883B	-55°C to +125°C	Military	8 Pin TO-99 Metal Can

Note:

1. /883B suffix denotes Mil-Std-883, Par. 1.2.1 compliant device.