



MOTOROLA

**MC4324
MC4024**

DUAL VOLTAGE-CONTROLLED MULTIVIBRATOR

The MC4324/4024 consists of two independent voltage-controlled multivibrators with output buffers. Variation of the output frequency over a 3.5-to-1 range is guaranteed with an input dc control voltage of 1.0 to 5.0 voltage.

Operating frequency is specified at 25 MHz at 25°C. Operation to 15 MHz is possible over the specified temperature range. For higher frequency requirements, see the MC1648 (200 MHz) or the MC1658 (125 MHz) data sheet.

This device was designed specifically for use in phase-locked loops for digital frequency control. It can also be used in other applications requiring a voltage-controlled frequency, or as a stable fixed frequency oscillator (3.0 MHz to 15 MHz) by replacing the external control capacitor with a series mode crystal.

Maximum Operating Frequency = 25 MHz Guaranteed @ 25°C
Power Dissipation = 150 mW typ/pkg
Output Loading Factor = 7

**DUAL
VOLTAGE-CONTROLLED
MULTIVIBRATOR**



**L SUFFIX
CERAMIC PACKAGE
CASE 632
(TO-116)**



**P SUFFIX
PLASTIC PACKAGE
CASE 646
(MC4024 only)**

TYPICAL APPLICATIONS

FIGURE 1 — ASTABLE MULTIVIBRATOR

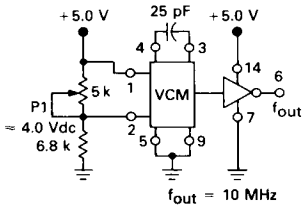

$f_{out} = 10 \text{ MHz}$

**FIGURE 2 — CRYSTAL CONTROLLED
MULTIVIBRATOR**

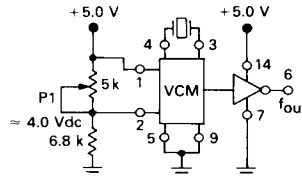

Crystal frequency can be pulled slightly by adjusting P1.

**FIGURE 3 — VOLTAGE-CONTROLLED
MULTIVIBRATOR**

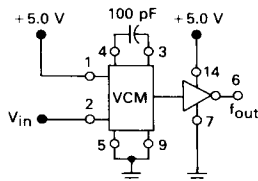

$V_{in} = 2.5 \text{ V to } 5.5 \text{ V}$
 $f_{out} = 1.0 \text{ MHz min, } 5.0 \text{ MHz max}$

PIN ASSIGNMENT

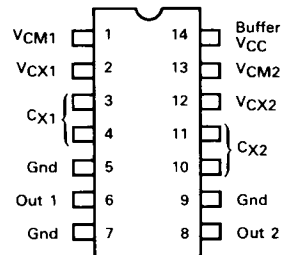

FIGURE 5 — FREQUENCY-CAPACITANCE PRODUCT

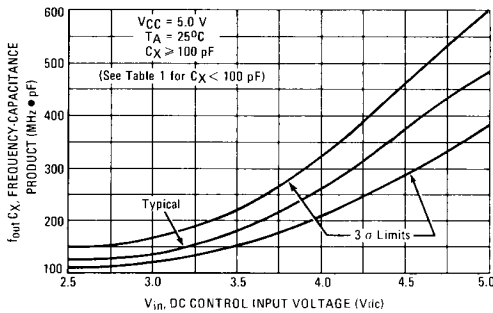

FIGURE 6 — FREQUENCY-VOLTAGE GAIN CHARACTERISTICS

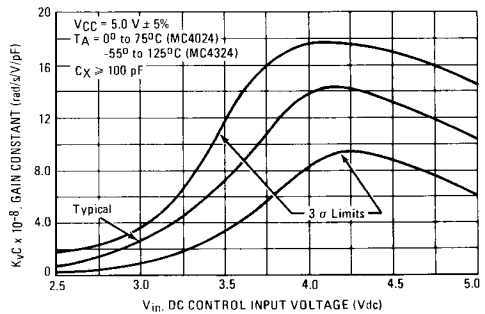

FIGURE 7 — TYPICAL FREQUENCY DEVIATION versus SUPPLY VOLTAGE

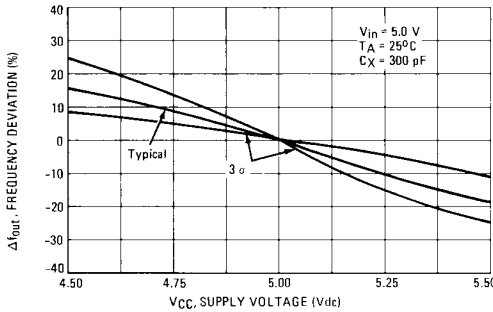

FIGURE 8 — TYPICAL FREQUENCY DEVIATION versus SUPPLY VOLTAGE

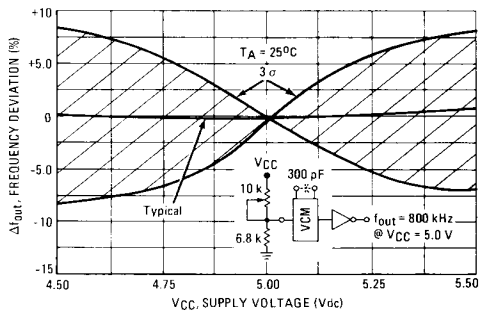

FIGURE 9 — FREQUENCY DEVIATION versus AMBIENT TEMPERATURE

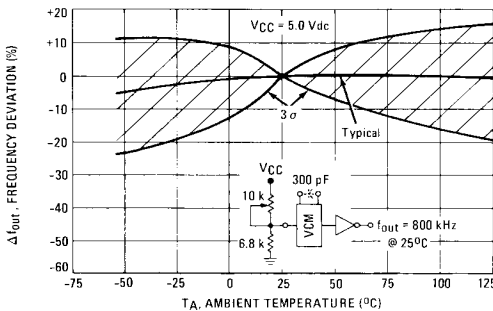
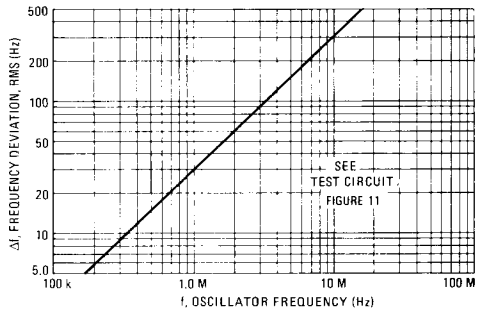

FIGURE 10 — RMS NOISE DEVIATION versus OSCILLATOR FREQUENCY



NOTE: Curves labeled as 3 σ limits denote that 99.7% of the devices tested fell within these limits.

6

FIGURE 11 — NOISE DEVIATION TEST CIRCUIT

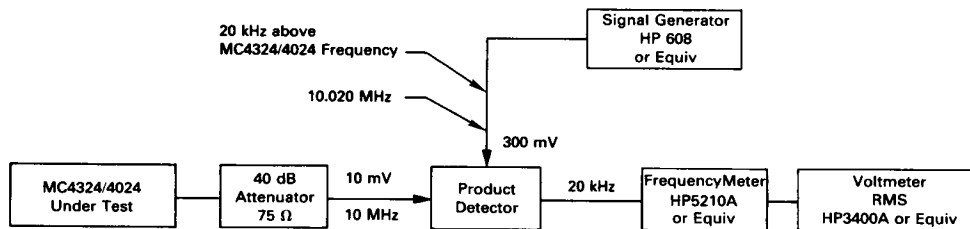

$$\text{Frequency Deviation} = \frac{(\text{HP5210A output voltage}) (\text{Full Scale Frequency})}{1.0 \text{ Volt}}$$

NOTE: Frequency deviation values of either the signal generator or power supply should be determined prior to testing.

APPLICATIONS INFORMATION

Suggested Design Practices

Three power supply and three ground connections are provided in this circuit (each multivibrator has separate power supply and ground connections, and the output buffers have common power supply and ground pins). This provides isolation between VCM's and minimizes the effect of output buffer transients on the multivibrators in critical applications. The separation of power supply and ground lines also provides the capability of disabling one VCM by disconnecting its V_{CC} pin. However, all ground lines must always be connected to insure substrate grounding and proper isolation.

General design rules are:

1. Ground pins 5, 7, and 9 for all applications, including those where only one VCM is used.
2. Use capacitors with less than 50 nA leakage at plus and minus 3.0 volts. Capacitance values of 15 pF or greater are acceptable.
3. When operated in the free running mode, the minimum voltage applied to the DC Control input should be 60% of V_{CC} for good stability. The maximum voltage at this input should be $V_{CC} + 0.5$ volt.
4. When used in a phase-locked loop, the filter design should have a minimum DC Control input voltage of 1.0 volt and a maximum voltage of $V_{CC} + 0.5$ volt. The maximum restriction may be waived if the output impedance of the driving device is such that it will not source more than 10 mA at a voltage of $V_{CC} + 0.5$ volt.
5. The power supply for this device should be bypassed with a good quality RF-type capacitor of 500 to 1000 pF. Bypass capacitor lead lengths should be kept as short as possible. For best results, power

supply voltage should be maintained as close to +5.0 V as possible. Under no conditions should the design require operation with a power supply voltage outside the range of 5.0 volts \pm 10%.

External Control Capacitor (C_X) Determination (See Table 1)

The operating frequency range of this multivibrator is controlled by the value of an external capacitor that is connected between X1 and X2. A tuning ratio of 3.5-to-1 and a maximum frequency of 25 MHz are guaranteed under ideal conditions ($V_{CC} = 5.0$ volts, $T_A = 25^\circ\text{C}$). Under actual operating conditions, variations in supply voltage, ambient temperature, and internal component tolerances limit the tuning ratio (see Figures 7 thru 12). An improvement in tuning ratio can be achieved by providing a variable tuning capacitor to facilitate initial alignment of the circuit.

Figures 5 through 9 show typical and suggested design limit information for important VCM characteristics. The suggested design limits are based on operation over the specified temperature range with a supply voltage of 5.0 volts \pm 5% unless otherwise noted. They include a safety factor of three times the estimated standard deviation.

Figures 5 and 6 provide data for any external control capacitor value greater than 100 pF. With smaller capacitor values, the curves are effectively moved downward. For example, a typical curve of frequency versus control voltage would be very nearly identical to the lower suggested design limit of Figure 5 if a 15 pF capacitor is used. To use Figure 5 divide on the ordinate by the capacitor

TABLE 1 — EXTERNAL CONTROL CAPACITOR VALUE DETERMINATION

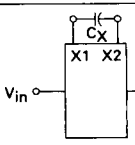
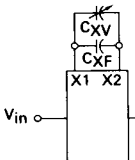
CONFIGURATION	T _A	V _{CC}	VALUES OF K				
			K1	K2	K3	K4	K5
 <p>With $C_X = \frac{K1}{f_{OH}} - 5$, $f_{OL} \leq \frac{K2}{C_X}$</p>	25°C ±3°C	5.0 V	385	150	600	110	1.0
		5.0 V ±5%	325	175	680	125	1.14
		5.0 V ±10%	290	190	750	140	1.25
 <p>$C_X = C_{XV} + C_{XF}$</p> <p>Choose C_{XF} and C_{XV} such that C_X can be adjusted to:</p> $\frac{K1}{f_{OH}} - 5 \leq C_X \leq \frac{K3}{f_{OH}} - 5$ <p>With V_{in} = V_{CC} = 5.0 V, adjust C_X to obtain:</p> $f_{out} = K5 (f_{OH})$ <p>Then:</p> $f_{OL} \leq \frac{K4}{K1} f_{OH}$	0°C to 75°C	5.0 V	335	165	660	120	1.10
		5.0 V ±5%	280	190	750	140	1.25
	5.0 V ±10%	250	200	840	150	1.40	
	-55°C to 125°C	5.0 V	300	175	690	125	1.15
		5.0 V ±5%	260	200	780	145	1.30
		5.0 V ±10%	230	210	860	155	1.45

Definitions: f_{OH} = Output frequency with $V_{in} = V_{CC}$
 f_{OL} = Output frequency with $V_{in} = 2.5$ V
(Frequencies in MHz, C_X in pF)

value in picofarads to obtain output frequency in megahertz. In Figure 6 the ordinate axis is multiplied by the capacitor value in picofarads to obtain the gain constant (K_Y) in radians/second/volt.

Frequency Stability

When the MC4324/4024 is used as a fixed-frequency oscillator (V_{in} constant), the output frequency will vary slightly because of internal noise. This variation is indicated by Figure 10 for the circuit of Figure 11. These variations are relatively independent (< 10%) of changes in temperature and supply voltage.

10-to-1 Frequency Synthesizer

A frequency synthesizer covering a 10-to-1 range is shown in Figure 14. Three packages are required to complete the loop: The MC4344/4044 phase-frequency detector, the MC4324/4024 dual voltage-controlled multi-vibrator, and the MC4318/4018 programmable counter.

Two VCM's (one package) are used to obtain the required frequency range. Each VCM is capable of operating over a 3-to-1 range, thus VCM1 is used for the lower portion of the times ten range and VCM2 covers the upper end. The proper divide ratio is set into the programmable counter and the VCM for that frequency is selected by control gates. The other VCM is left to be free running since its output is gated out of the feedback path.

Normally with a single VCM the loop gain would vary over a 10-to-1 range due to the range of the counter ratios. This affects the bandwidth, lockup time, and damping ratio severely. Utilizing two VCM's reduces this change in loop gain from 10-to-1 to 3-to-1 as a result of the different sensitivities of the two VCM's due to the different frequency ranges. This change of VCM sensitivity (3-to-1) is of such a direction of compensate for loop gain variations due to the programmable counter.

The overall concept of multi-VCM operation can be expanded for ranges greater than 10-to-1. Four VCM's (two packages) could be used to cover a 100-to-1 range.

FIGURE 12 — 10-TO-1 FREQUENCY SYNTHESIZER

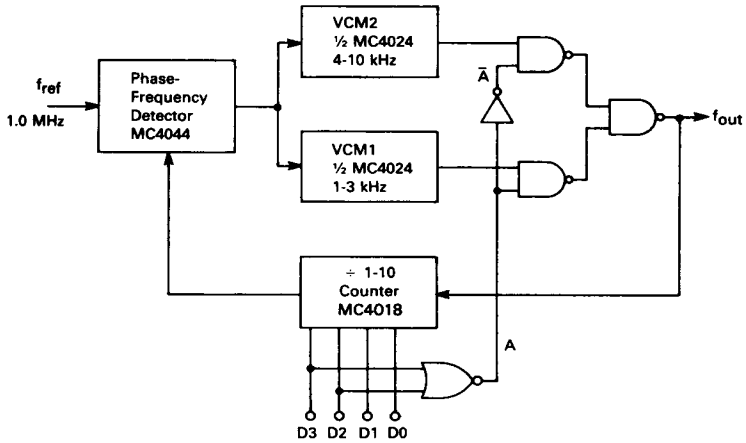

+ N	Input				A	VCM1 kHz	VCM2 kHz	f _{out} kHz
	D3	D2	D1	D0				
1	0	0	0	1	1	1	X	1
2	0	0	1	0	1	2	X	2
3	0	0	1	1	1	3	X	3
4	0	1	0	0	0	X	4	4
5	0	1	0	1	0	X	5	5
6	0	1	1	0	0	X	6	6
7	0	1	1	1	0	X	7	7
8	1	0	0	0	0	X	8	8
9	1	0	0	1	0	X	9	9
10	1	0	1	0	0	X	10	10